

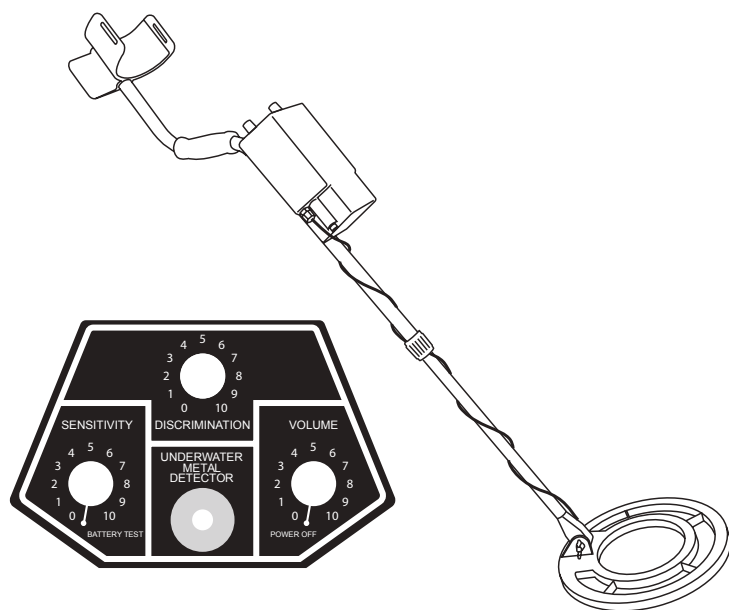

WINBEST[®]

by  BARSKA[®]

Premiere Edition Metal Detector



Easy to Use

Automatic tuning and ground balancing

LED Indicator

Flashes red when a target is detected

Submersible Detector

100% Waterproof works in fresh and salt water up to 32.8 feet / 10 meters

Treasure Hunter's Code of Ethics	3
Parts of the Metal Detector	3
Assembly	4
Batteries	4
Checking Battery Levels	4
Control Panel	5
Sensitivity	5
Discrimination	6
Using the Metal Detector	7
On Land	7
Underwater	7
Search Coil Sweeping Hints	7
Search Coil Positioning	7
Ultra Slow Motion	8
Audio Pitch	8
Correct Arm Position	8
Pinpointing a Target	8
Using Headphones	9
Care and Maintenance	9
Warranty	10

TREASURE HUNTER'S CODE OF ETHICS

A few basic rules you should follow while using your detector

- Always get permission before searching any site
- Respect the rights and property of others
- Observe all national, state and local laws when treasure hunting
- Never destroy historical or archaeological treasures. If you are not sure about an object you have found, contact a museum or historical society in your area.
- Leave the land and vegetation as is, and fill in any holes you dig.
- Use the detector only in safe areas
- Dispose of any junk you may find, only in approved areas. Do not leave it for the next treasure hunter find.

PARTS OF THE METAL DETECTOR

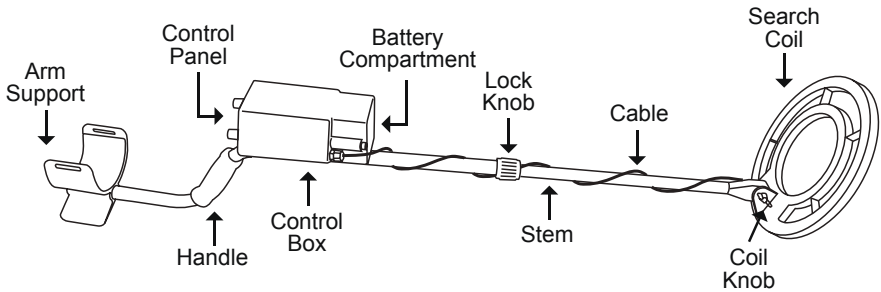

ASSEMBLY

Only a few adjustments are needed and requires no tools.

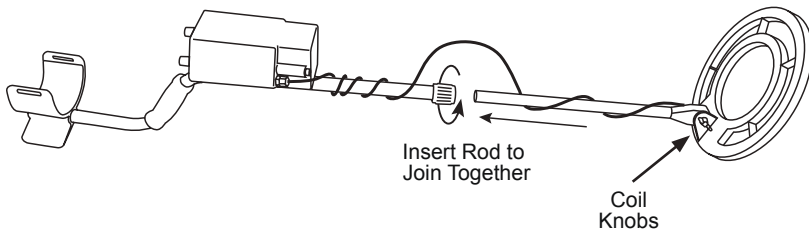

1. Insert stem into lock knob.
2. Adjust the stem to the appropriate length. To extend or retract the lower stem, loosen the lock knob clockwise and pull or push in the lower stem to desired length. Then, turn counter clockwise to tighten the lock knob in place.
3. Adjust the search coil to the scanning position. If necessary, loosen the coil knob and then tighten coil knob.

Notes:



WINBEST® by BARSKA®

- As you increase the shaft length, you need to put forth your strength more with your wrist and arm.
- For use to search over the land or shallow water, please keep the coil with the level of ground at least 1" from surface.
- For diving, the stem's length should be as short as possible.

BATTERIES

1. Locate the battery door cover.
Loosen both screws and remove battery door.
2. Insert 8 AA batteries and connect the batteries with the correct polarity.
3. Place battery door cover back on the battery box.
4. Tighten down both battery cover screws.

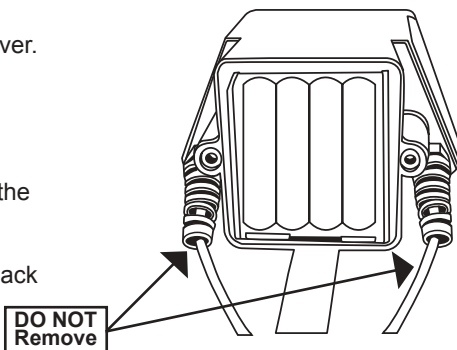

Notes

- Make sure that the rubber seal is properly aligned with the cover and control box and not pinched between door and battery box.
- DO NOT over tighten the screws!
- DO NOT remove the two waterproof seal/strain relief's where the headphone wire and search coil wires exits

Checking Battery Levels

Make sure the volume control is set to its maximum position before testing and headphones are not too close to your ears. Rotate the sensitivity control counterclockwise until it clicks into the battery test mode. Place metal detector over metal object to see battery level.

	Audio	LED Light
Good	Loud audio sound	Bright
Weak	Faint audio sound	Dim
Dead	No Sound Replace batteries as soon as possible	None

Caution:

- Only use fresh batteries of the required size and type.
- Do not mix the old and fresh batteries different types of batteries.
- Remove the batteries from the metal detector if you do not plan to use the detector for a long time.
- Dispose of old batteries promptly and properly. Never bury or burn them.





WINBEST® by BARSKA®

CONTROL PANEL

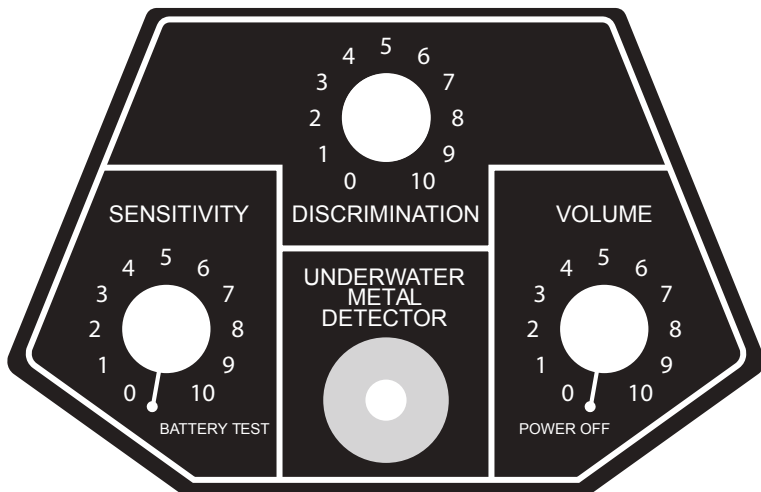

Power/Volume Control	Turns the power on and off
	Controls the volume in the headphones
Discrimination Control	A full range junk metal filter. All types of metal are detected at 0 (zero) level and most small pieces of trash are eliminated at the maximum level of 10 (ten)
Sensitivity Control Battery Level Test	A setting of 10 gives you maximum sensitivity options
	Initiates battery testing
LED Light Located between the sensitivity and the volume control	Flashes red when a target is detected
	Visual results of battery test (See Checking Battery Levels)

Operation of the Sensitivity

This control is extremely helpful in elimination false signals caused by high minerals.

The normal sensitivity range is between 6 and 7 and good for most soil conditions. If you are experiencing false signals you should decrease this control until these false signals are minimized.

TIP: Try running the detector at the highest sensitivity range of 10 you will get better depth on older coins with minimal false signals.





WINBEST[®] by BARSKA[®]

Operation of the Discrimination Control

The discrimination control is used to reject or discriminate unwanted trash targets.

When the control is set to "0", metal detector will be in the All-Metal Mode and will respond to any metal targets.

By increasing the control to a higher number, the detector will begin to reject small iron targets first, then most small foil pieces, and then pull tabs.

Study the below chart in this section to get a better understanding of the different levels that trash target are eliminated.

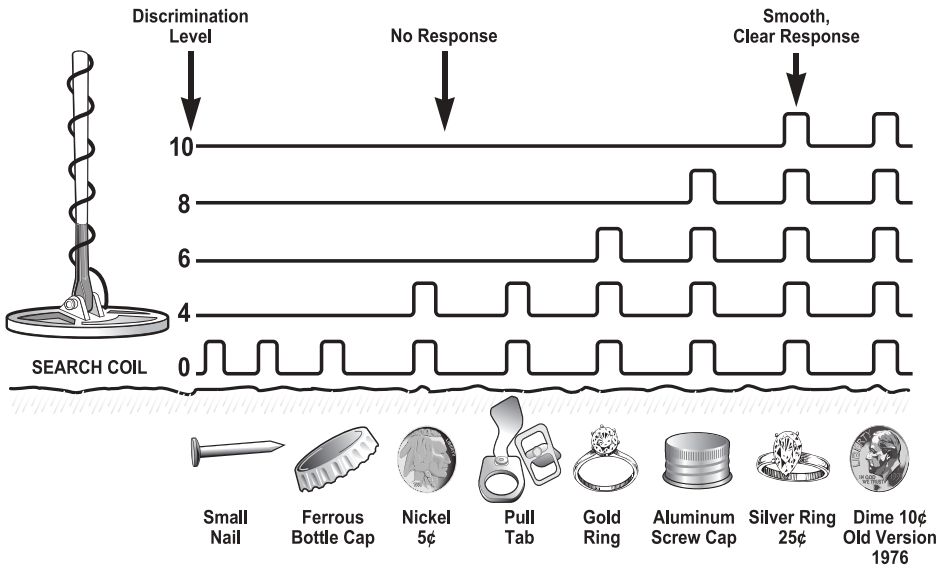

NOTE: The discrimination levels shown are typical values only and may vary from detector to detector.

TIP: Always keep the discrimination control at its lowest possible settings, so you will not reject nickels and small gold rings.

NOTE: once level of volume stays the same, the pattern of the tone is used to indicate what kind of metal target has been detected. Please refer to the details as below:

Most trash targets will give a broken or chattered sound. When they are discriminated, this is normal and is a design feature of this underwater detector. It was designed by this way, so you can easily identify trash targets. Some trash targets will give no sound at all. Practice how to



WINBEST[®] by BARSKA[®]

use the discrimination control by putting different coins and trash items on the ground in a straight line about 10 inches apart. Pass each item once and come back to increase the discrimination control knob by one number. Then, listen to the changes in the audio response on the trash targets, as you keep increasing the control by one. Remember that even good targets can be eliminated at the maximum discrimination settings.

Using the Metal Detector

On Land

After familiarizing yourself with the sensitivity and discrimination controls you are now ready to use the metal detector

1. Turn metal detector on by turning the Power/Volume Control clockwise. The same control also adjusts the hearing volume.
2. Adjust the sensitivity control and the discrimination control as needed.

Underwater

Works in fresh and salt water up to 10 meters

While descending or ascending under water, keep the headset around your neck, off your ears to make sure that you observe the surroundings more clearly. The recommended stem length for underwater use is the shortest stem length with the search coil adjusted parallel to the seabed or lake bottom. Follow "On Land" steps as above.

SEARCH COIL SWEEPING HINTS

Search Coil Positioning

Always keep the bottom of the coil level with the ground. Never sweep the search coil as if it were a pendulum. Raising the search coil while sweeping or at the end of a sweep will cause false readings. Try to maintain coil 1 inch off the ground, seabed or lake bottom at all times.



Ultra Slow Motion

The detector is an ultra-slow motion metal detector. The coil must be in slow motion to detect any target.

By simply moving the coil back and forth over the ground, this motion will activate the automatic ground balance and tuning circuits of you detector and keep it at its optimum tuning levels.

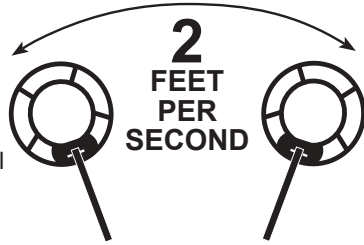

Audio Pitch

Keep the search coil about 1 inch off the ground. The highest audio pitch is when item detected is in the center of the search coil.

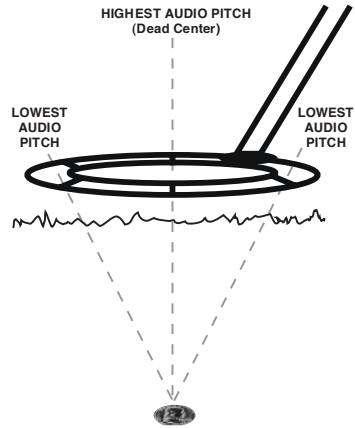

Correct Arm Position

Adjust the lower stem so that your arm is hanging in a comfortable position by your side with the coil about 1 inch off the ground. It is better that you sweep the search coil from side to side in an arc line of 3 inches motion and keep the search coil parallel with the ground. As you increase the shaft length, you also increase the strain on your wrist and arm.

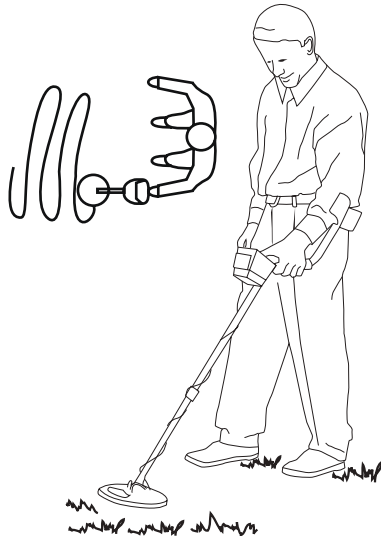

PINPOINTING A TARGET

Accurate pinpointing takes practice and is best accomplished by crossing sweep the target area.

1. Once a buried target is indicated by a clear tone response, continue sweeping the coil over the target in a narrowing side-to-side motion.
2. Take visual note of the place on



WINBEST[®] by BARSKA[®]

- the ground where the “beep” sounds.
3. Stop the coil directly over this spot on the ground.
 4. Now move the coil straight forward and straight back towards you a couple of times.
 5. Again make visual note of the spot on the ground at which the “beep” sounds.
 6. If needed, cross sweep the target in “X” pattern at different angles to “zero in” on the exact spot on the ground at which the “beep” sounds.

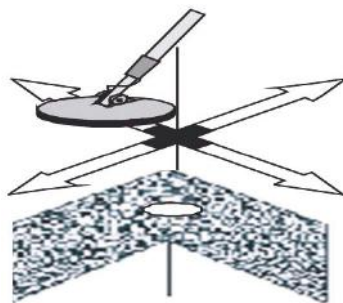

USING HEADPHONES

The features permanently attached waterproof headphones. They are unable to be removed from the metal detector. If they are damaged or need service, you must return the entire detector assembly to repair or get the replacement. To protect your hearing, follow these guidelines when using headphones.

- DO NOT wear headphones while operating your detector near high-traffic areas. Pay attention to traffic safety.
- After you begin listening, adjust the volume to a comfortable level.
- Do not listen at extremely high volume levels. Extended high volume listening can lead to permanent hearing loss.
- Once you set the volume, do not increase it. Over time, your ears adapt to the volume level, so a volume level that does not cause discomfort might still damage your hearing.

CARE AND MAINTENANCE

Your metal detector is an example of superior design and craftsmanship. The following suggestions will help you care for your metal detector so you can enjoy it for years.

- Handle the detector gently and carefully. Dropping it can damage circuit boards and cases and can cause the detector to work improperly.
- Use the detector only in normal temperature environments. Temperature extremes can shorten the life of electronic devices and damage the cases of the detector.
- Keep the detector away from dust and dirt, which can cause premature wear of parts.
- Wipe the detector with a damp cloth occasionally to keep it looking new. Do not use harsh chemicals, cleaning solvents, or strong detergents to clean the detector.





1 YEAR LIMITED WARRANTY

Metal Detector

WINBEST® by BARSKA®, as manufacturer, warrants this new product to be free of original defects in materials and/or workmanship for the length of time specified by this warranty. This warranty does not include damage caused by abuse, improper handling, installation, maintenance, normal wear-and-tear, unauthorized repairs or modifications and tampering in anyway.

This warranty is limited to the original purchaser and is not transferable. This warranty applies only to products purchased in the United States of America.

In the event of a defect within 30 days, the consumer must return the defective unit to the WINBEST® by BARSKA® dealer (the place of purchase) at his/her own expense.

Beyond 30 days, WINBEST® by BARSKA® products should be sent to the following address for warranty repairs. Products must be packed carefully and sturdily to prevent damage in transit, and returned freight prepaid to:

WINBEST® by BARSKA®
855 Towne Center Drive
Pomona, CA 91767

For additional and updated information
please visit www.barska.com

Please email info@barska.com or call 1.888.666.6769 for Return Merchandise Number (RMA#) before any returns.

NOTE: All merchandise received without a valid RMA# will be returned to shipper at his/her own expense.

Please include all of the following when returning WINBEST® by BARSKA® products for service and/or replacement:

1. Please write your complete details (Name, Address, Telephone #, E-mail address, RMA#, etc.)
 2. Purchase receipt or Proof of Purchase. (Original/Copy)
 3. A brief explanation of the defect
 4. A Check/Money Order of \$35.00 to cover inspection, shipping and handling
- *Please allow 6-8 weeks for delivery

This product will either be replaced or repaired at the discretion of the warrantor. If it's a discontinued item, we will replace the product with an equivalent product. Should the repair not be covered by this warranty, an estimate will be sent for your approval. Non-warranty repairs or refurbishing are always provided at a reasonable cost.

WINBEST® by BARSKA® shall not be liable for any consequential, incidental and/or contingent damages whatsoever. We will not pay shipping, insurance or transportation charges from you to us, or any import fees, duties and or taxes. This warranty supersedes all previous Winbest® by BARSKA warranties.